

TLP197G

Modem

Fax

PBX

Measurement Instrumentation

The TOSHIBA mini flat photo relay TLP197G is a small outline photo relay, suitable for surface mount assembly. The TLP197G consists of an gallium arsenide infrared emitting diode optically coupled to a photo-MOS FET in a six lead 2.1mm height package, which enable TLP197G to be applied in card modems. The TLP197G is a bi-directional switch which can replace mechanical relays in fax machines and modems etc.

- SOP 6pin(2.54SOP6): 1-form-A
- Peak off-state voltage: 350V (min)
- Trigger LED current: 3mA (max)
- On-state current: 120mA(max)
(A connection)
- On-state resistance: 35Ω(max)
- Isolation voltage: 1500Vrms (min)
- UL recognized: UL1577, file No./E67349
- BSI approved: BS EN60065: 1994, certificate No.8273
BS EN60950: 1992, certificate No.8274
- SEMKO approved: SS EN60065
SS EN60950
- Option(V4)type
TUV approved: DIN VDE0884 / 06.92,
certificate no.R9850580

Unit in mm

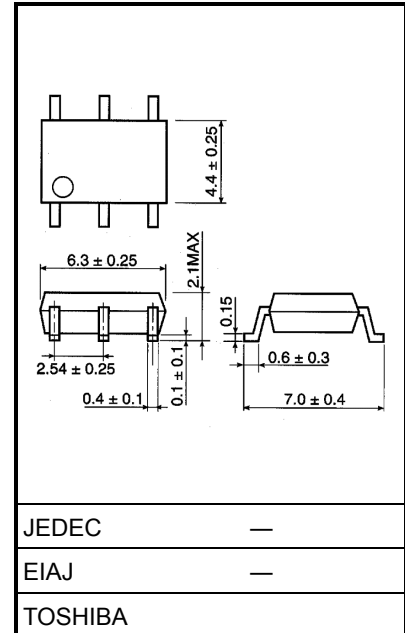

Weight: 0.13g

Pin Configuration (top view)

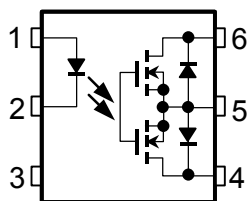

- 1 : Anode
- 2 : Cathode
- 3 : NC
- 4 : Drain D1
- 5 : Source
- 6 : Drain D2

1-Form-a

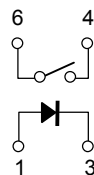

Schematic

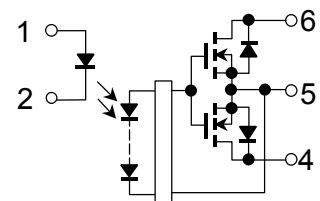

Maximum Ratings (Ta = 25°C)

Characteristics		Symbol	Rating	Unit	
Led	Forward current	I_F	50	mA	
	Forward current derating (Ta ≥ 25°C)	$\Delta I_F/^\circ\text{C}$	-0.5	mA/°C	
	Pulse forward current (100μs pulse, 100pps)	I_{FP}	1	A	
	Reverse voltage	V_R	5	V	
	Junction temperature	T_j	125	°C	
Detector	Off-state output terminal voltage	V_{OFF}	350	V	
	On-state current	A connection	I_{ON}	120	mA
		B connection			
		C connection			
	On-state current derating (Ta ≥ 25°C)	A connection	$\Delta I_{ON}/^\circ\text{C}$	-1.2	mA/°C
		B connection			
		C connection			
Junction temperature	T_j	125	°C		
Storage temperature range	T_{stg}	-55~125	°C		
Operating temperature range	T_{opr}	-40~85	°C		
Lead soldering temperature(10 s)	T_{sol}	260	°C		
Isolation voltage (AC, 1 min., RH ≤ 60%)	(Note 1) BV_S	1500	Vrms		

(Note 1): Device considered a two-terminal device: Pins 1, 2 and 3 shorted together and pins 4, 5 and 6 shorted together.

Recommended Operating Conditions

Characteristic	Symbol	Min.	Typ.	Max.	Unit
Supply voltage	V_{OFF}	—	—	280	V
Forward current	I_F	5	7.5	25	mA
On-state current(A connection)	I_{ON}	—	—	100	mA
Operating temperature	T_{opr}	-20	—	65	°C

Circuit Connections

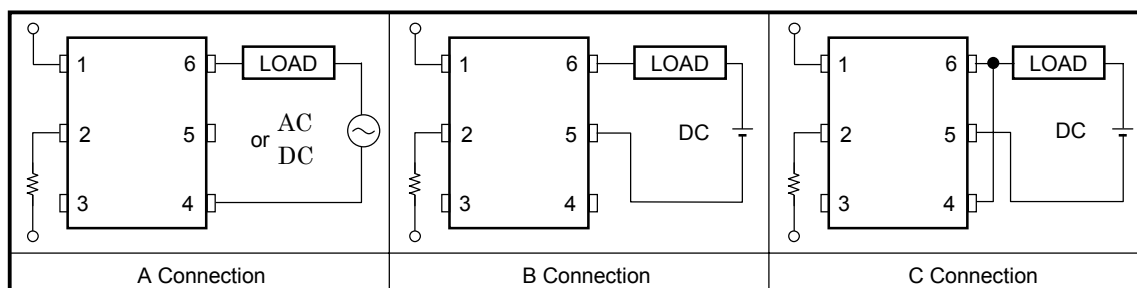

Individual Electrical Characteristics (Ta = 25°C)

Characteristic		Symbol	Test Condition	Min.	Typ.	Max.	Unit
Led	Forward voltage	V_F	$I_F=10\text{mA}$	1.0	1.15	1.3	V
	Reverse current	I_R	$V_R=5\text{V}$	—	—	10	μA
	Capacitance	C_T	$V=0, f=1\text{MHz}$	—	30	—	pF
Detector	Off-state current	I_{OFF}	$V_{OFF}=350\text{V}$	—	—	1	μA
	Capacitance	C_{OFF}	$V=0, f=1\text{MHz}$	—	40	—	pF

Coupled Electrical Characteristics (Ta = 25°C)

Characteristic		Symbol	Test Condition	Min.	Typ.	Max.	Unit
Trigger LED current		I_{FT}	$I_{ON}=120\text{mA}$	—	1	3	mA
On-state resistance	A connection	R_{ON}	$I_{ON}=120\text{mA}, I_F=5\text{mA}$	—	22	35	Ω
			$I_{ON}=20\sim 120\text{mA}, I_F=5\text{mA}$	—	26	40	

Isolation Characteristics (Ta = 25°C)

Characteristic	Symbol	Test Condition	Min.	Typ.	Max.	Unit
Capacitance input to output	C_S	$V_S=0, f=1\text{MHz}$	—	0.8	—	pF
Isolation resistance	R_S	$V_S=500\text{V}, \text{R.H.} \leq 60\%$	5×10^{10}	10^{14}	—	Ω
Isolation voltage	BV_S	AC, 1minute	1500	—	—	V_{rms}
		AC, 1second (in oil)	—	3000	—	V_{dc}
		DC, 1minute (in oil)	—	3000	—	

Switching Characteristics (Ta = 25°C)

Characteristic	Symbol	Test Condition	Min.	Typ.	Max.	Unit
Turn-on time	t_{ON}	$R_L=200\Omega$ (Note 2)	—	0.3	1	ms
Turn-off time	t_{OFF}	$V_{CC}=20\text{V}, I_F=5\text{mA}$	—	0.1	1	

(Note2): Switching time test circuit

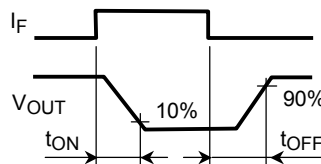
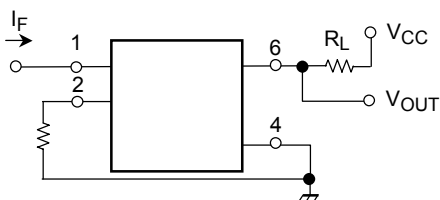

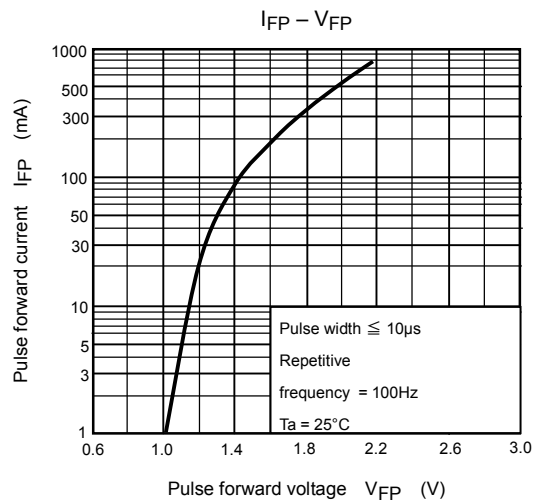
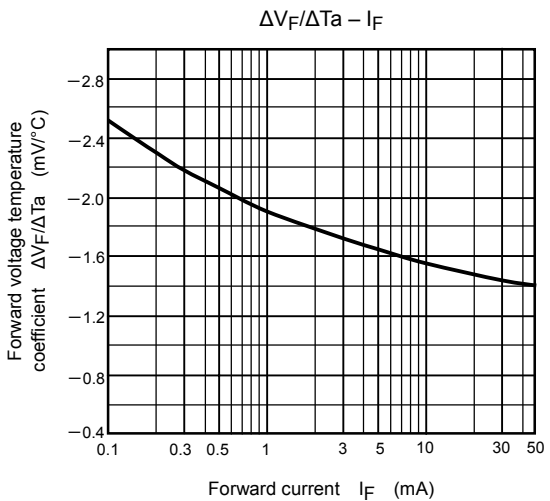
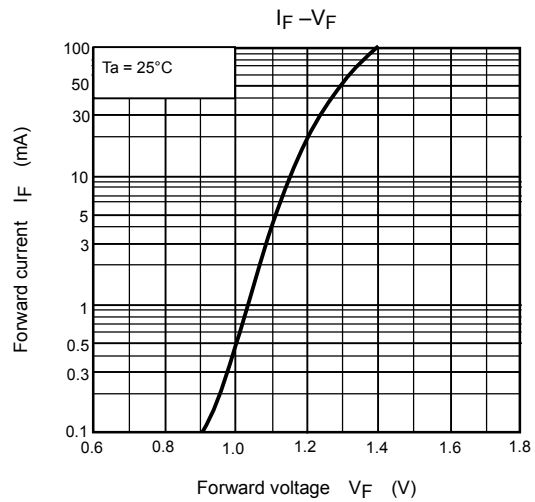
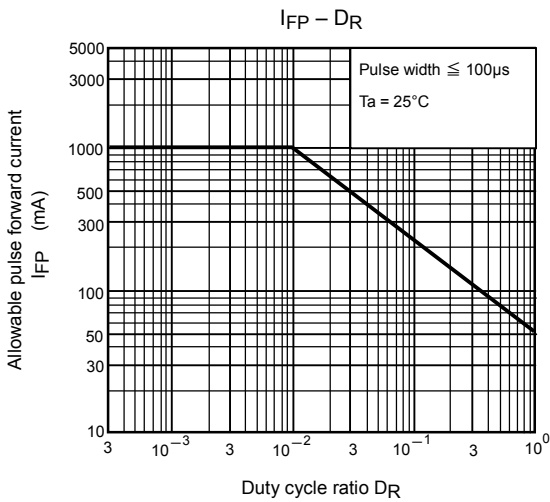
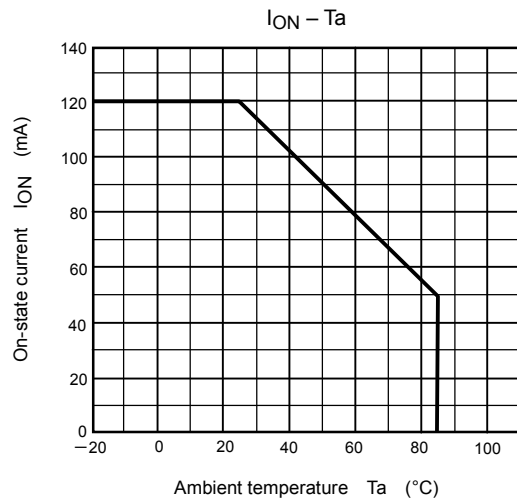
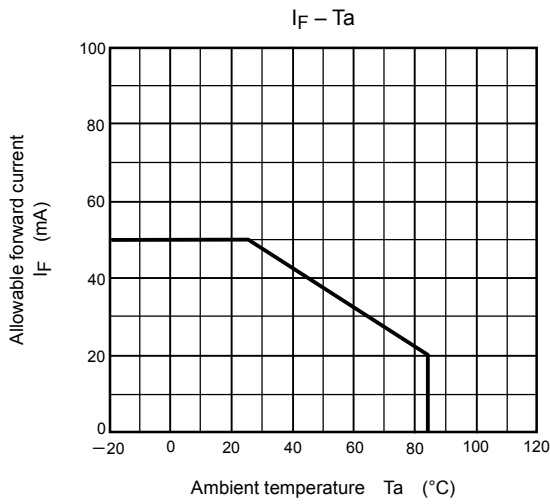

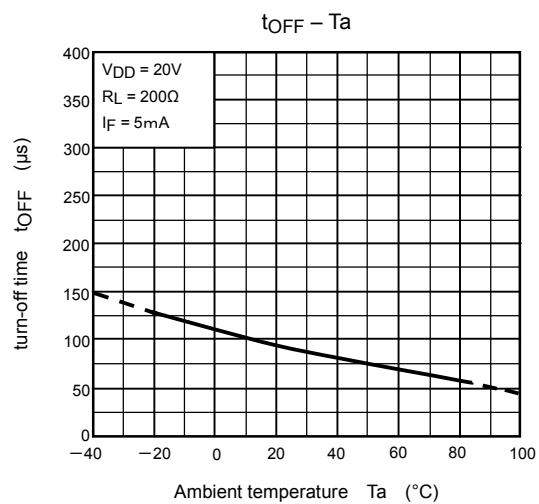
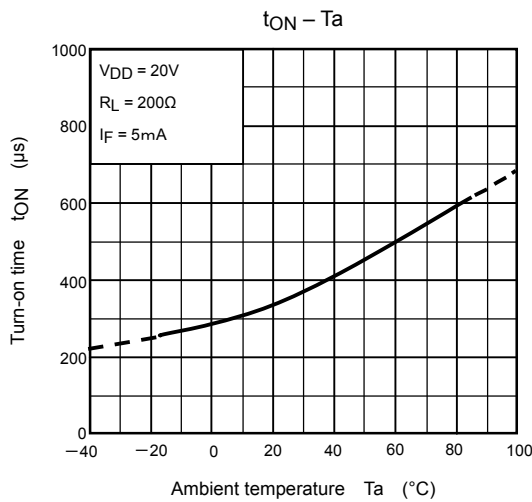
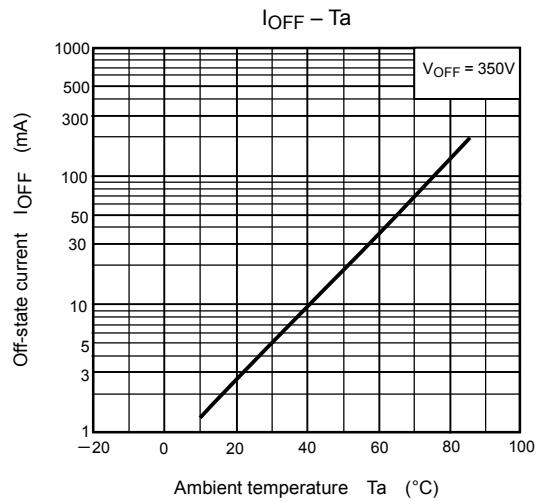
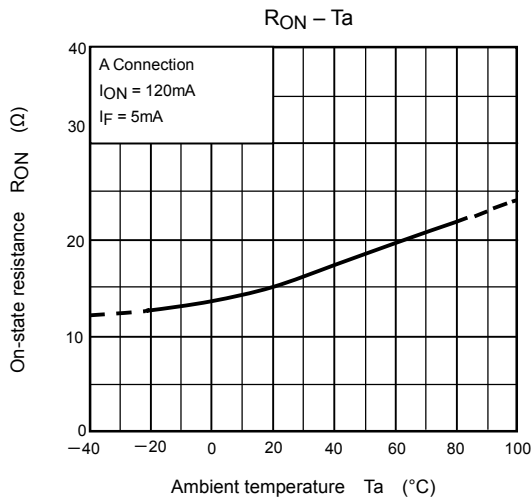
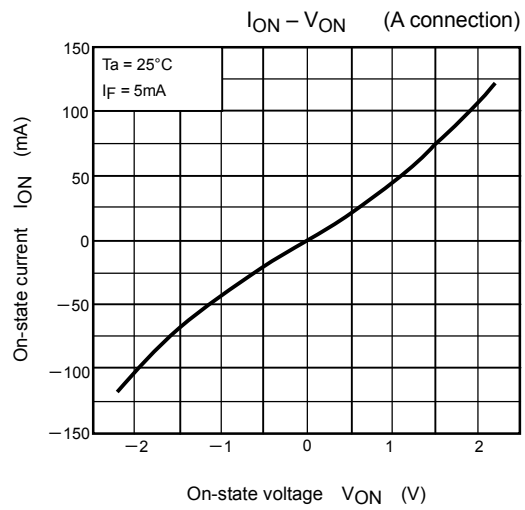
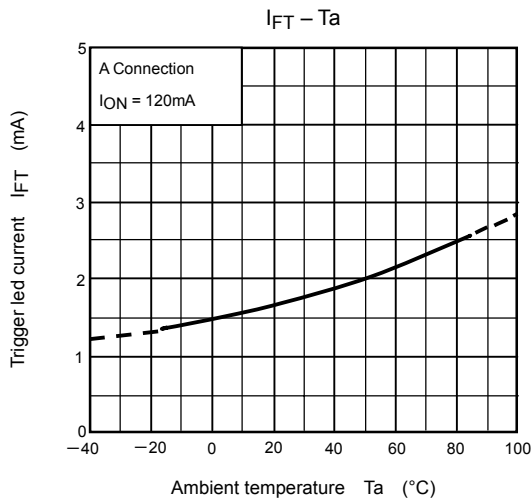

RESTRICTIONS ON PRODUCT USE

000707EBC

- TOSHIBA is continually working to improve the quality and reliability of its products. Nevertheless, semiconductor devices in general can malfunction or fail due to their inherent electrical sensitivity and vulnerability to physical stress. It is the responsibility of the buyer, when utilizing TOSHIBA products, to comply with the standards of safety in making a safe design for the entire system, and to avoid situations in which a malfunction or failure of such TOSHIBA products could cause loss of human life, bodily injury or damage to property.
In developing your designs, please ensure that TOSHIBA products are used within specified operating ranges as set forth in the most recent TOSHIBA products specifications. Also, please keep in mind the precautions and conditions set forth in the "Handling Guide for Semiconductor Devices," or "TOSHIBA Semiconductor Reliability Handbook" etc..
- The TOSHIBA products listed in this document are intended for usage in general electronics applications (computer, personal equipment, office equipment, measuring equipment, industrial robotics, domestic appliances, etc.). These TOSHIBA products are neither intended nor warranted for usage in equipment that requires extraordinarily high quality and/or reliability or a malfunction or failure of which may cause loss of human life or bodily injury ("Unintended Usage"). Unintended Usage include atomic energy control instruments, airplane or spaceship instruments, transportation instruments, traffic signal instruments, combustion control instruments, medical instruments, all types of safety devices, etc.. Unintended Usage of TOSHIBA products listed in this document shall be made at the customer's own risk.
- Gallium arsenide (GaAs) is a substance used in the products described in this document. GaAs dust and fumes are toxic. Do not break, cut or pulverize the product, or use chemicals to dissolve them. When disposing of the products, follow the appropriate regulations. Do not dispose of the products with other industrial waste or with domestic garbage.
- The products described in this document are subject to the foreign exchange and foreign trade laws.
- The information contained herein is presented only as a guide for the applications of our products. No responsibility is assumed by TOSHIBA CORPORATION for any infringements of intellectual property or other rights of the third parties which may result from its use. No license is granted by implication or otherwise under any intellectual property or other rights of TOSHIBA CORPORATION or others.
- The information contained herein is subject to change without notice.